

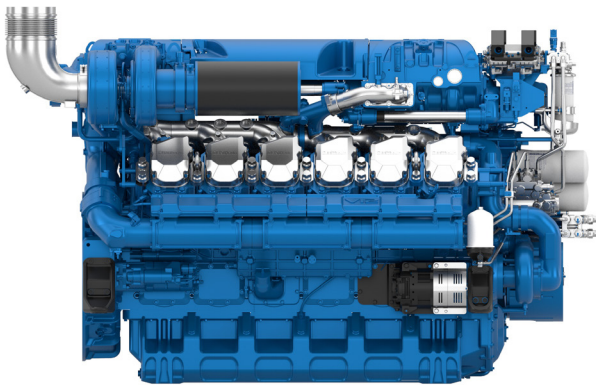

12M26.3

Propulsion Diesel Engine



Number of cylinders	12V @ 90
Bore and stroke (mm)	150 X 150
Total displacement (L)	31.8
Compression ratio	15/1
Engine rotation	counter clockwise
Idle speed	650
Flywheel	SAE 0
Flywheel housing	SAE 18"

Customer benefits

Adheres to strict emission regulations and competitive performance as it is equipped with Most advanced common rail technology and high end injection system (2200 bar)

Efficient fuel consumption, thanks to the highly efficient turbochargers

Easy maintenance due to individual cylinder heads

Highly reliable key components ensuring longevity

Life cycle cost efficiency with extended mean time between overhauls

Rated power - Fuel consumption

Duty	kW	HP	RPM	Fuel consumption			IMO	EPA	CCNR	CE97/68
				Optimum value	Rated power					
					g/kWh	g/kWh				
P1	883	1200	1800	200	200	207	II/III	3/4	II	III A
P2	972	1320	1800	199	201	232	II	-	II	III A
P2	1030	1400	2100	199	206	250	II/III	3/4	II	III A
P2	1103	1500	2200	200	211	275	II/III	3/4	II	
P3	1214	1650	2300	205	215	311	II/III	3/4	-	-

* Other power ratings are available on request

	P1	P2	P3
Application	Unrestricted Continuous	Continuous	Intermittent
Engine load variations	Very Little To None	Continuous	Important
Average Engine load factor	80-100%	30-80%	60%
Annual working time	More Than 5000 H	3000 -5000 H	1000 - 3000 H
Time at full load	Unlimited	8h Each 12h	2h Each 12h

P1 Continuous Duty

- Deep sea trawlers
- Shrimps trawlers
- Sea going tug boats
- River tug boats
- Push boats
- Freighters
- Dredges
- LCT
- Ferries

P2 Heavy Duty

- Deep sea trawlers
- Shrimps trawlers
- Sea going tug boats
- River tug boats
- Push boats
- Freighters
- Dredges
- LCT
- Ferries

P3 Intermittent Duty

- Seasonal passenger vessels
- Fishing boats
- Pilot boats
- Commercial pleasure boats
- Pump boats
- Displacement sailboats
- Trawlers
- Bow thrusters

P4 Light Duty

- Private pleasure boats
- Multi-hull pleasure boats
- Survey or rescue fast vessels
- Military fast vessels.

P5 High performance Duty

- Private pleasure boats
- Multi-hull pleasure boats

Dimensions and dry weight (mm/kg)

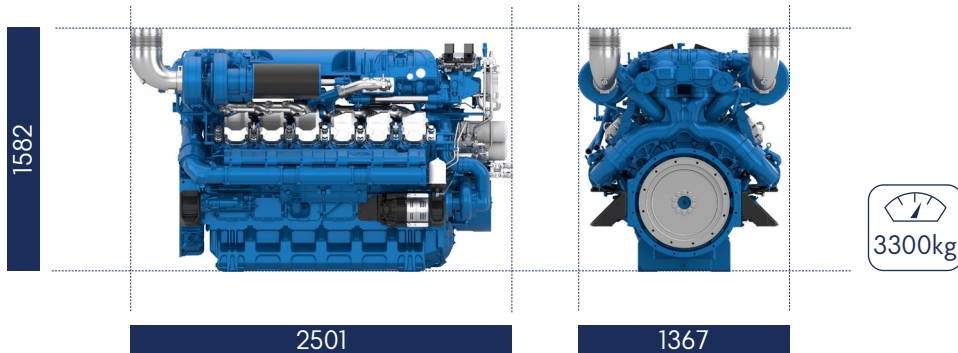

Standard equipment

Cooling System

Two - stage cooling circuit with built - in HT thermostatic valve
 Integrated fresh water expansion tank
 High efficiency tubular heat exchanger
 Gear driven centrifugal raw water pump
 Self priming raw water pump with bronze impeller

Lubrication System

Full flow lube oil filters duplex type
 Fresh water cooled lube oil heat exchanger

Fuel System

Common-rail electronic injection
 High pressure pump with shielded high pressure injection rail and pipes
 Fuel oil filter duplex type
 External fuel pre-filter with water separator

Intake Air and Exhaust System

Double flow raw water cooled intake air heat exchanger module
 High efficiency dry turbocharger with ball bearing technology

Electrical System

Voltage: 24V DC insulated
 Electrical starter
 190A battery alternator

Optional Equipment

Wet exhaust
 PTO elastic coupling
 Additional pulley
 Electric drain system
 Standard PTO for hydraulic pump
 Different alternators possible - including 12V
 Electrical rotary actuator

Performance

P1 - 883 kW - 1200 hp @1800rpm

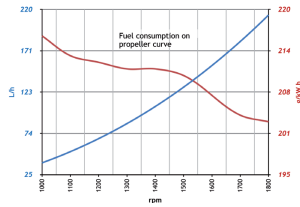
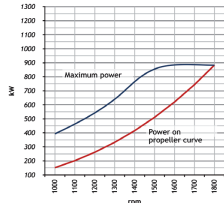
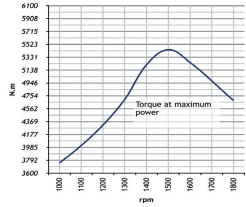

P2 - 970 kW - 1320 hp @1800rpm

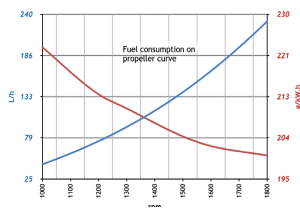
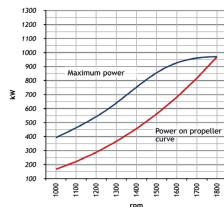
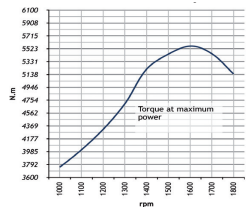

P2 - 1030 kW - 1500 hp @2100rpm

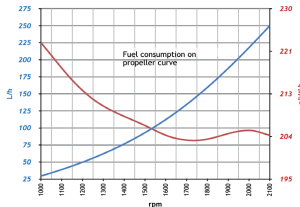
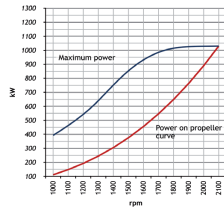
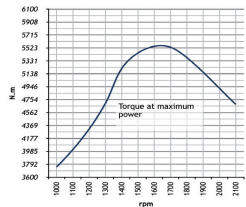

P2 - 1104 kW - 1500 hp @2200rpm

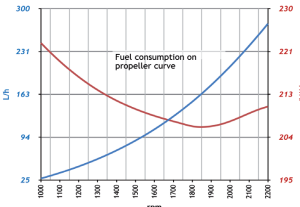
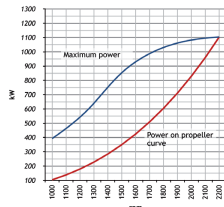
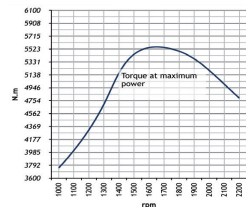

P3 - 1214 kW - 1650 hp @2300rpm

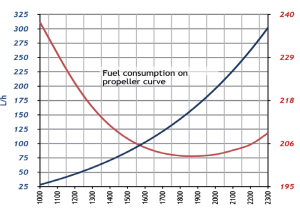
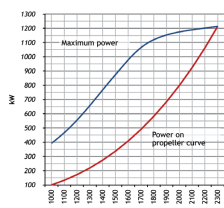
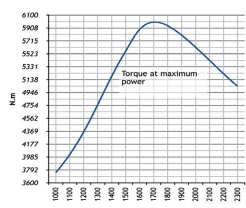

Power definition

(Standard ISO 3046/1 - 1995 (F))

Reference conditions

Ambient temperature	25°C / 77°F
Barometric pressure	100 kPa
Relative humidity	30%R
Raw water temperature	25°C / 77°F

Fuel oil

Relative density	0,840 ± 0,005
Lower calorific power	42 700 kJ/kg
Consumption tolerances	+ 5%
	(DIN ISO 3046-1)
Inlet limit temperature	35°C / 95°F

Our ratings also comply with classification societies maximum temperature definition without power derating.

Ambient temperature	45°C / 113°F
Raw water temperature	32°C / 90°F

M.P.S.12M263.EN.06.23 Moteurs Baudouin reserve the right to modify these specifications, without notice. Document not contractual.